



OIL-FREE ROTARY SCROLL COMPRESSOR
ECOLIFE 1,5 – 15 kW

T E C H N O L O G Y Y O U C A N T R U S T

Why

The continuous innovation of the compressed air tools and machineries, the evolution of specific productive processes and uses, require exclusively air without oil.

It is easier and less hazardous to produce non-lubricated compressed air than to de-oil the compressed air contaminated by oil using more or less complicated filter assemblies.



MARK, always sensitive to the market needs, in order to answer these needs, offers the series "ECOLIFE".

A new compressor with innovative features, reliable, compact, noiseless and capable of producing compressed air without oil.

A double spiral without contact among the parts for an innovative NON-lubricated compressor.

The scroll compressor

The compression from the atmospheric pressure to the final pressure occurs gradually and without contact among the moving metallic parts in a progressive and continuous way through the combined action of the fixed helicoidal element equipped with a second spinning element.

The continuous repetition of this process allows to have at the delivery compressed air with a continuous flow.

The absence of lubricant in the compression chamber allows to have at the delivery compressed air without oil.



Phase 1
Suction
Compression



Phase 2
Compression



Phase 3
Compression



Phase 4
Compression
Delivery

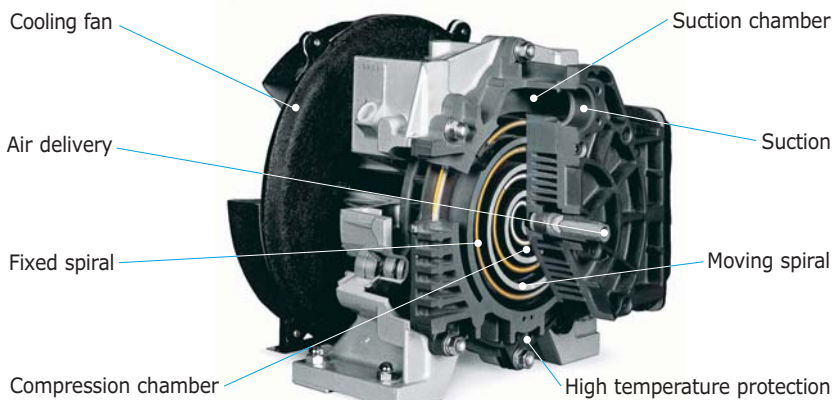

Few moving parts, the absence of vibrations, the use of reliable materials, the structure of the compressor itself, and the long test period under extreme conditions represent our guarantee of a safe and reliable machine in time.

Standard

The **STANDARD** series has been developed with the aim of producing a non-lubricated compressor having a simple construction, at reduced costs, and being reliable.

Thanks to its modular features it is available:

- in three versions : on skid - on tank - tandem on tank
- with two power supplies : single-phase for 2 kW – three-phase for the others
- with five powers : 2 - 3 - 5 - 8 - 10 kW
- with two pressure sizes : 8 - 10 bar

Specifically suitable for uses in which the only choice is air without oil.

Silenced, non-lubricated compressor, on basement

SKID version, complete and ready for installation.

Typically used for specific applications, as:
direct connection to a using machine; extension
of existing plants; OEM applications in general.
It covers a power range from 2 to 5 kW.



Silenced, non-lubricated compressor, on tank



TANK version, made up of the compressor, as in Skid version, assembled on collection tank, in steel sheets, zinc-plated, complying with the current European Directives and equipped with all use accessories.

It covers a series of power range from 2 to 5 kW, on 270 litre tank.

Silenced, non-lubricated compressor, tandem on tank

The **TANDEM** version is a unit made up of two Skid compressors assembled on a single tank as the previous version, with a second compressor and it can work as stock or as support in case the need of air should be higher than the yield of the single compressor.

Particularly suitable for the most common uses requiring air without oil with variable consumption values or requiring a stock.
It covers a series of power range from 8 to 10 kW, on a 500 litre tank.



Super

The series **SUPER** has been developed to produce a non-lubricated compressor with superior quality, i.e. low noise level and dry air in the DRY version.

Thanks to its modular features it is available:

- in four versions : super - multi-super, with or without dryer
- with two power supplies : single-phase for 2 kW - three-phase for the other models
- with seven powers : 2 - 3 - 5 - 8 - 10 - 15 - 20 kW
- with two pressure sizes : 8 - 10 bar

Thanks to its low noise level "54 - 63 dB(A)", it is specifically suitable to be installed in any working environment.

Super-silenced, non-lubricated compressor

It covers a series of power range from 2 to 5 kW



Particularly suitable for installations close to use points, with direct association to the using machine, or as extension of an existing plant.

SUPER version: Structurally it is like the Skid version with super-silencing cover and with command and control panel.

SUPER DRY version: It is made up of compressor, as in version Super, with embedding within the same structure of a dryer with an ecological refrigerating cycle with gas R134a and indicator of the dew point.

Super-silenced, non-lubricated multiple compressor

It covers a series of power range from 8 to 20 kW.

Used in applications where the consumption of compressed air can be very variable, or where there is the need to have a stock always available.

SUPER MULTI version: it is made up of two or more "Super" compressors integrated in a single structure.

SUPER MULTI DRY is made up as the previous one, with embedding in the same structure of a dryer with refrigerating cycle, as above.



"Es Ecolife"



The versions Multi and Multi Dry are equipped with an electronic regulator "**ES ECOLIFE**". User-friendly, this device controls the operation of the various modules optimizing their use according to the compressed air request and levelling their respective operation hours.

All information is displayed on an alphanumeric display.

Ecolife



Installation

Compact and noiseless, it does not require special installation operation, it is enough to connect it to the power supply network and to the air distribution network.

The overall height dimensions allow to place the compressor even under the usual working surfaces.

The condensate does not contain oil.

Maintenance

A simple compressor designed to offer the maximum duration reliability in time.

An easy access to the internal components makes any maintenance intervention easier.

Constant pressure

The combined and continuous action of the spinning element generates an air flow at delivery without pulsations.

The pressure during use is therefore quite constant improving the stability of the production process.

Non-lubricated

The absence of metallic contacts between the two spirals enables the compression without addition of lubricating greases and oils.

The absence of lubricants in the compression chamber allows to obtain delivery compressed air without oil.

Noiseless

Thanks to its innovative system, the compressor ECOLIFE is extremely noiseless under any operation condition.

Therefore it can be installed also close to working places.















Ecological

CLEANER ENVIRONMENT
No oil in the air = no oil in the condensate.

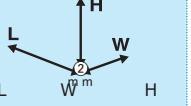

NOISE
Up to 65 dB(A) in the standard version, only 54 - 63 dB(A) in the Super versions.

TECHNICAL DATA (ACCORDING TO ISO 1217 AND CAGI PNEUROP PN8NTC2)

Type	 bar	 psi	 HP	 kW	 m ³ /1'	 m ³ /h	 cfm	 dB(A)	 V/Hz/Ph	 gas		 kg	 Kg	 litres	
FLOOR MOUNTED Version															
OFMS 1/8	8	116	2	1,5	0,162	9,7	5,7	65	230/50/1	1/2"	800	600	540	105	-
OFMS 1/10	10	145	2	1,5	0,126	7,5	4,4	65	230/50/1	1/2"	800	600	540	105	-
OFMS 2/8	8	116	3	2,2	0,240	14,4	8,5	67	400/50/3	1/2"	800	600	540	110	-
OFMS 2/10	10	145	3	2,2	0,204	12,2	7,2	67	400/50/3	1/2"	800	600	540	110	-
OFMS 4/8	8	116	5	3,7	0,396	23,8	14,0	68	400/50/3	1/2"	800	600	540	120	-
OFMS 4/10	10	145	5	3,7	0,336	20,2	11,9	68	400/50/3	1/2"	800	600	540	120	-
TANK MOUNTED Standard and Tandem Version															
OFMS 1/8-270	8	116	2	1,5	0,162	9,7	5,7	65	230/50/1	1/2"	1267	600	1169	180	270
OFMS 1/10-270	10	145	2	1,5	0,126	7,5	4,4	65	230/50/1	1/2"	1267	600	1169	180	270
OFMS 2/8-270	8	116	3	2,2	0,240	14,4	8,5	67	400/50/3	1/2"	1267	600	1169	185	270
OFMS 2/10-270	10	145	3	2,2	0,204	12,2	7,2	67	400/50/3	1/2"	1267	600	1169	185	270
OFMS 4/8-270	8	116	5	3,7	0,396	23,8	14,0	68	400/50/3	1/2"	1267	600	1169	195	270
OFMS 4/10-270	10	145	5	3,7	0,336	20,2	11,9	68	400/50/3	1/2"	1267	600	1169	195	270
OFMS 6/8-500 T	8	116	8	6	0,636	38,2	22,5	72	400/50/3	1/2"	2043	600	1169	365	500
OFMS 6/10-500 T	10	145	8	6	0,540	32,4	19,1	72	400/50/3	1/2"	2043	600	1169	365	500
OFMS 8/8-500 T	8	116	10	7,5	0,792	47,5	28,0	73	400/50/3	1/2"	2043	600	1169	375	500
OFMS 8/10-500 T	10	145	10	7,5	0,672	40,3	23,7	73	400/50/3	1/2"	2043	600	1169	375	500
SUPER Version															
OFMS 1/8 S	8	116	2	1,5	0,162	9,7	5,7	54	230/50/1	1/2"	590	600	1040	97	-
OFMS 2/8 S	8	116	3	2,2	0,240	14,4	8,5	54	400/50/3	1/2"	590	600	1040	97	-
OFMS 2/10 S	10	145	3	2,2	0,168	10,1	5,9	54	400/50/3	1/2"	590	600	1040	97	-
OFMS 4/8 S	8	116	5	3,7	0,402	24,1	14,2	54	400/50/3	1/2"	590	600	1040	102	-
OFMS 4/10 S	10	145	5	3,7	0,252	15,1	8,9	54	400/50/3	1/2"	590	600	1040	102	-
SUPER DRY Version															
OFMS 1/8 SD	7,75	112	2	1,5	0,162	9,7	5,7	54	230/50/1	1/2"	590	600	1040	120	-
OFMS 2/8 SD	7,75	112	3	2,2	0,240	14,4	8,5	54	400/50/3	1/2"	590	600	1040	120	-
OFMS 2/10 SD	9,75	142	3	2,2	0,168	10,1	5,9	54	400/50/3	1/2"	590	600	1040	120	-
OFMS 4/8 SD	7,75	112	5	3,7	0,402	24,1	14,2	54	400/50/3	1/2"	590	600	1040	125	-
OFMS 4/10 SD	9,75	142	5	3,7	0,252	15,1	8,9	54	400/50/3	1/2"	590	600	1040	125	-
SUPER MULTI DRY Version															
OFMS 6/8 M	8	116	8	6	0,624	37,4	22,0	63	400/50/3	1/2"	1450	750	1040	340	-
OFMS 6/10 M	10	145	8	6	0,528	31,7	18,6	63	400/50/3	1/2"	1450	750	1040	340	-
OFMS 8/8 M	8	116	10	7,5	0,762	45,7	26,9	63	400/50/3	1/2"	1450	750	1040	345	-
OFMS 8/10 M	10	145	10	7,5	0,678	40,7	23,9	63	400/50/3	1/2"	1450	750	1040	345	-
OFMS 11/8 M	8	116	15	11	1,134	68,0	40,0	60	400/50/3	1/2"	1450	750	1844	480	-
OFMS 11/10 M	10	145	15	11	1,020	61,2	36,0	60	400/50/3	1/2"	1450	750	1844	480	-
OFMS 15/8 M	8	116	20	15	1,482	88,9	52,3	63	400/50/3	1/2"	1450	750	1844	560	-
OFMS 15/10 M	10	145	20	15	1,368	82,9	48,3	63	400/50/3	1/2"	1450	750	1844	560	-
SUPER MULTI DRY Version															
OFMS 6/8 MD	7,75	112	8	6	0,624	37,4	22,0	63	400/50/3	1/2"	1450	750	1040	370	-
OFMS 6/10 MD	9,75	142	8	6	0,528	31,7	18,6	63	400/50/3	1/2"	1450	750	1040	370	-
OFMS 8/8 MD	7,75	112	10	7,5	0,762	45,7	26,9	63	400/50/3	1/2"	1450	750	1040	375	-
OFMS 8/10 MD	9,75	142	10	7,5	0,678	40,7	23,9	63	400/50/3	1/2"	1450	750	1040	375	-
OFMS 11/8 MD	7,75	112	15	11	1,134	68,0	40,0	60	400/50/3	1/2"	1450	750	1844	515	-
OFMS 11/10 MD	9,75	142	15	11	1,020	61,2	36,0	60	400/50/3	1/2"	1450	750	1844	515	-
OFMS 15/8 MD	7,75	112	20	15	1,482	88,9	52,3	63	400/50/3	1/2"	1450	750	1844	595	-
OFMS 15/10 MD	9,75	142	20	15	1,368	82,9	48,3	63	400/50/3	1/2"	1450	750	1844	595	-

D = Dry version - M = Multi - S = Super - T = Tandem
 ① Reference conditions: Air suction pressure: 1 bar (a) Air suction temperature: 20 °C
 ② Dimensions in mm.

The company reserves the right to perform possible modifications aiming at the continuous improvement of the products.



According to

